

DOSIMAX

FILLING MACHINE

MIMAC





DOSIMAX
FILLING MACHINE



www.mimac.com



Veloci, pratiche ed affidabili le DOSIMAX sono state progettate per il dosaggio o iniezione di creme, marmellate, salse, yogurt, maionese etc. DOSIMAX XL si distingue dal modello base per il gruppo pompa con dimensioni maggiori, per il motore più potente e per la velocità di dosaggio variabile.

Fast, practical and reliable, DOSIMAX was designed to deposit or inject creamy fillings, jams, sauces, yogurt, mayonnaise, etc. DOSIMAX XL is different from the basic model because of the bigger pump unit, the more powerful motor and variable dosing speed.

Rapides, pratiques et fiables, les DOSIMAX ont été conçues pour le dosage et l'injection de crèmes, confitures, sauces, yogourts, mayonnaises, etc. DOSIMAX XL se distingue du modèle de base par son groupe pompe aux dimensions plus importantes, par son moteur plus puissant et par sa vitesse de dosage variable.

Rápidas, prácticas y fiables, las DOSIMAX se han diseñado para la dosificación o la inyección de cremas, mermeladas, salsas, yogures, mayonesas, etc. DOSIMAX XL se distingue del modelo base por el grupo bomba de dimensiones mayores, por el motor más poderoso y por la velocidad de dosificación variable.



www.mimac.com



L'innovativa strumentazione elettronica prevede l'utilizzo di DOSIMAX in tre modalità: manuale, automatica o sequenziale. Quantità di prodotto e antigocciolamento sono regolabili e memorizzabili.

DOSIMAX, with its innovative electronic instruments, can be used in three different ways: manual, automatic or sequential. The product quantity and the suction function can be adjusted and saved.

Son instrumentation électronique innovatrice prévoit l'utilisation de DOSIMAX en trois modalités: manuelle, automatique ou séquentielle. La quantité de produit et le système anti-gouttes sont réglables et mémorisables.









La instrumentación innovadora prevé el uso de DOSIMAX en tres modalidades: manual, automática o secuencial. Cantidad de producto y antigoteo pueden regularse y memorizarse.

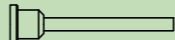

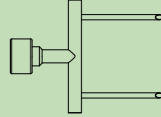
DOTAZIONI STANDARD - STANDARD EQUIPMENT
DOTATION STANDARD - DOTACIONES DE SERIE

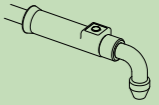
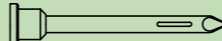
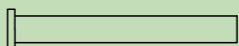
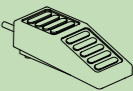
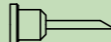
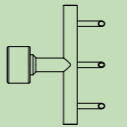
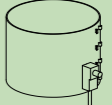
	SP11 Ø 8 mm L= 80 mm		SP14 Ø 6 mm L= 60 mm		SP16 Ø 6 mm L= 50 mm P= 90 mm
---	-----------------------------------	---	-----------------------------------	---	---

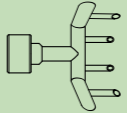
ACCESSORI EXTRA - EXTRA ACCESSORIES
ACCESSOIRES EXTRA - ACCESORIOS EXTRAS

	SP10 Ø 10 mm L= 100 mm		SP21 Ø 15 mm L= 130 mm		SP29 Ø 6 mm L= 95 mm P= 90 mm
	SP12 Ø 12 mm L= 130 mm		SP22 Ø 15 mm L= 150 mm		PISTOLA DOSAGGIO Flexible hose Pistolet de dosage Manguera de dosificación
	SP13 Ø 12 mm L= 130 mm		SP23 Ø 20 mm L= 180 mm		START A PEDALE Foot control pad Commande à pieds Pedal de mando
	SP15 Ø 6 mm L= 50 mm		SP24 Ø 6 mm L= 30 mm P= 45 mm		FASCIA RISCALDANTE Heating jacket Ceinture chauffante Cinta de calefacción
	SP17 Ø 8 mm L= 95 mm		SP25 Ø 6 mm L= 30 mm P= 30 mm		TRAMOGGIA 7 lt. Hopper 7 lt. Trémie 7 lt. Tolva 7 lt.

Una vasta gamma di accessori da impiegare a seconda della tipologia di prodotto rende le DOSIMAX versatili e funzionali.

A wide range of accessories to be used according to the type of product makes the DOSIMAX machines versatile and functional.

Une vaste gamme d'accessoires à utiliser selon la typologie de produit rend les DOSIMAX polyvalentes et fonctionnelles.

Una amplia gama de accesorios que se pueden utilizar en función del tipo de producto vuelve las DOSIMAX versátiles y funcionales.



Optional:
Supporto gruppo dosaggio
Dosing unit support
Support groupe de dosage
Soporte grupo de dosificación



Optional:
Fascia riscaldante
Heating jacket
Ceinture chauffante
Cinta de calefacción



www.mimac.com

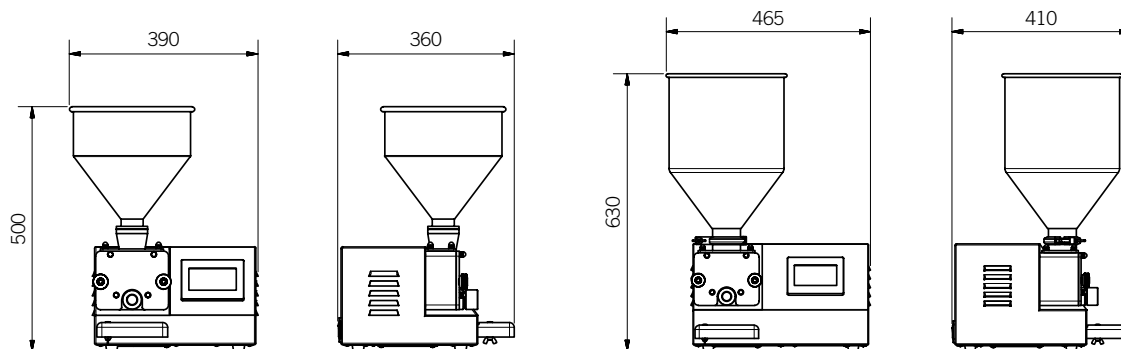

DOSIMAX

DOSIMAX XL

DATI TECNICI - TECHNICAL DATA

DONNEES TECHNIQUES - DATOS TÉCNICOS

	DOSIMAX	DOSIMAX XL
Capacità tramoggia - Hopper capacity - Capacité trémie - Capacidad tolva	7 lt.	15 lt.
Peso - Weight - Poids - Peso	20 kg	27 kg
Potenza - Power - Puissance - Potencia	0,22 kW	0,4 kW



MIMAC ITALIA s.r.l.

Via dell'Industria, 22

36013 **PIOVENE ROCCHETTE**

Vicenza - Italy

Tel. +39 0445 576 250

Fax +39 0445 576 112

www.mimac.com

info@mimac.com

MIMAC ITALIA S.R.L.

Si riserva il diritto di apportare eventuali modifiche tecniche e costruttive
 Reserves the right to make any technical and structural modification
 Se réserve le droit d'apporter éventuelles modifications et de construction
 Se reserva la facultad de aportar eventuales modificaciones técnicas y constructivas